



OZ Optics

www.ozoptics.com

219 Westbrook Rd, Ottawa, ON, Canada, K0A 1L0 Toll Free: 1-800-361-5415 Tel:(613) 831-0981 Fax:(613) 836-5089 E-mail: sales@ozoptics.com

VARIABLE FIBER OPTIC ATTENUATORS – BLOCKING PIGTAIL STYLE

Features:

- Rugged and compact size
- Wide wavelength range
- Singlemode, polarization maintaining and multimode fiber versions
- Low PDL and wavelength dependency
- High power handling
- High attenuation range
- Low backreflection
- Designed to meet Telcordia standards
- Low cost

Applications:

- Optical power equalization and power control for WDMs and multi-channel optically amplified networks
- Telecommunications
- CATV
- LAN
- Test and measurement
- Receiver padding
- Optical sensors

Product Description:

OZ Optics offers a complete line of low cost, compact PC board mountable pigtail style variable attenuators with low backreflection. These attenuators are designed to meet Telcordia standards. These attenuators can be used for 1300nm and 1550nm, as well as for C (1520-1570nm), L (1570-1620nm) and S (1470-1520nm) bands, with minimal changes in the insertion loss. Mounting holes provide easy attachment to PC boards and patch panels. The mounting hole patterns and attenuator sizes can be modified to meet our customer requirements on OEM orders.

The attenuators consist of two collimating lenses, prealigned for optimum coupling efficiency. A threaded radial screw is used to block the collimated beam between the two lenses. Because the attenuator works by directly blocking the beam, it is polarization insensitive. A seal cap is used to seal the junction against temperature and humidity effects. The attenuator can even withstand immersion in water for extended periods of time.

Attenuators are offered with singlemode, multimode, or polarization maintaining fibers. In general, OZ Optics uses polarization maintaining fibers based on the PANDA fiber structure when building polarization maintaining components and patchcords. However OZ Optics can construct devices using other PM fiber structures. We do carry some alternative fiber types in stock, so please contact our sales department for availability. If necessary, we are willing to use customer supplied fibers to build devices.

Neutral density filter versions of attenuators are also available in rectangular and reflector style housings. See the data sheets titled "Variable Fiber Optic Attenuator-Reflective Style" and "Variable Fiber Optic Attenuators Neutral Density Filter Version-Pigtail Style".

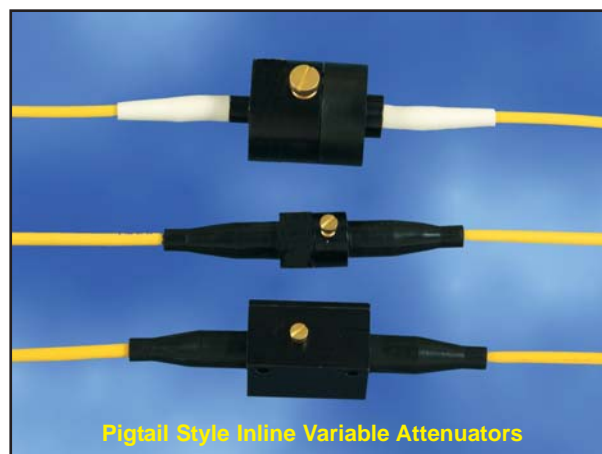

Pigtail Style Inline Variable Attenuators



Miniature Pigtail Style
Inline Variable Attenuators

Standard Product Specifications:

Model		BB-100, BB-400, BB-500 & BB-700
Insertion loss:	Standard	≤1.5dB
	Low Loss Versions Backreflection 40, 50dB	1dB
	Low Loss Versions Backreflection = 60dB	0.6dB
Backreflection:	Singlemode or PM	40, 50 or 60dB
	Multimode	35dB
Power handling ¹	40dB or 50dB Backreflection	Up to 2 Watts
	60dB Backreflection	Up to 2 Watts
Attenuation range		Up to 80dB
Wavelength dependence ^{2, 3}		
	From 1300nm to 1550nm:	< 0.3dB
	From 1520 to 1570 or from 1570 to 1620nm (C and L bands):	Up to 0.05dB
Available wavelengths ⁴		400 -1625nm
Temperature Dependence ³	(-35° C to +70°C)	
	Typical:	±0.3dB change in attenuation
	Maximum:	±0.5dB change in attenuation
Storage Temperature		-40° C to +85° C
Humidity Dependence ³ (10% to 90% humidity)		±0.2dB change in attenuation
Drop test ⁵		±0.2dB change in attenuation
Vibration (Between 10Hz to 55Hz)		≥ 0.05dB change in attenuation
Water immersion test ⁶		±0.1dB
Polarization sensitivity ^{2, 3}		Up to 0.01dB
Polarization Extinction ratio ⁷		≥20dB Standard, ≥25dB Medium ³ , ≥30dB Premium ³

Notes:

¹ Higher power levels can be offered. Please contact OZ Optics.

² Measured at 23°C, at minimum attenuation.

³ 1300/1550 wavelength modes only.

⁴ For wavelengths <1290nm, specify actual wavelength. For any wavelength from 1290-1625, 1300/1550 can be used.

⁵ After 4 drops from a height of 1 meter onto a hard surface.

⁶ Over 7 days submerged to a depth of 15cm in water at room temperature.

⁷ For PM fibers, only.

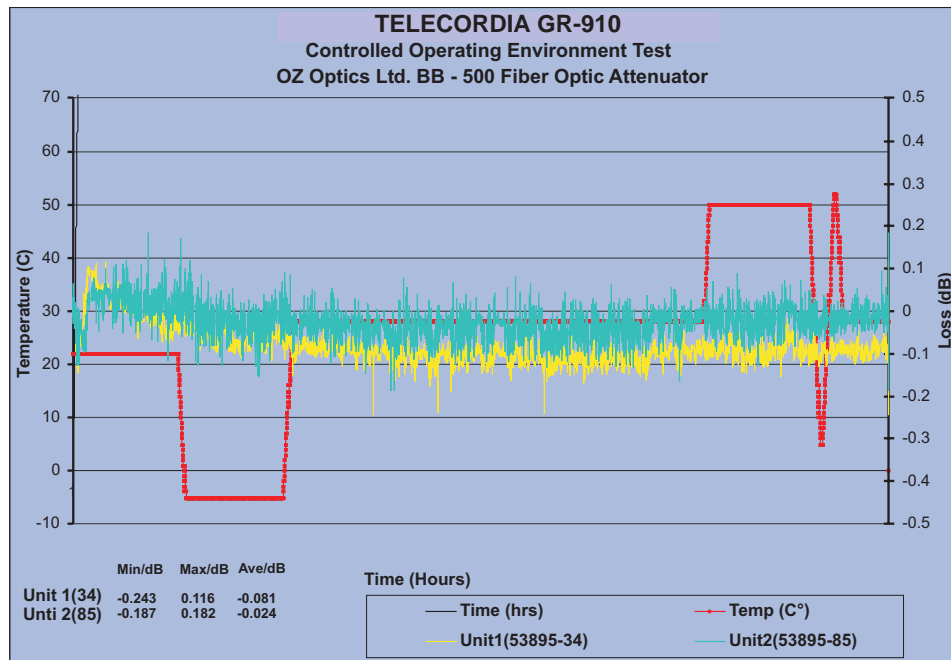

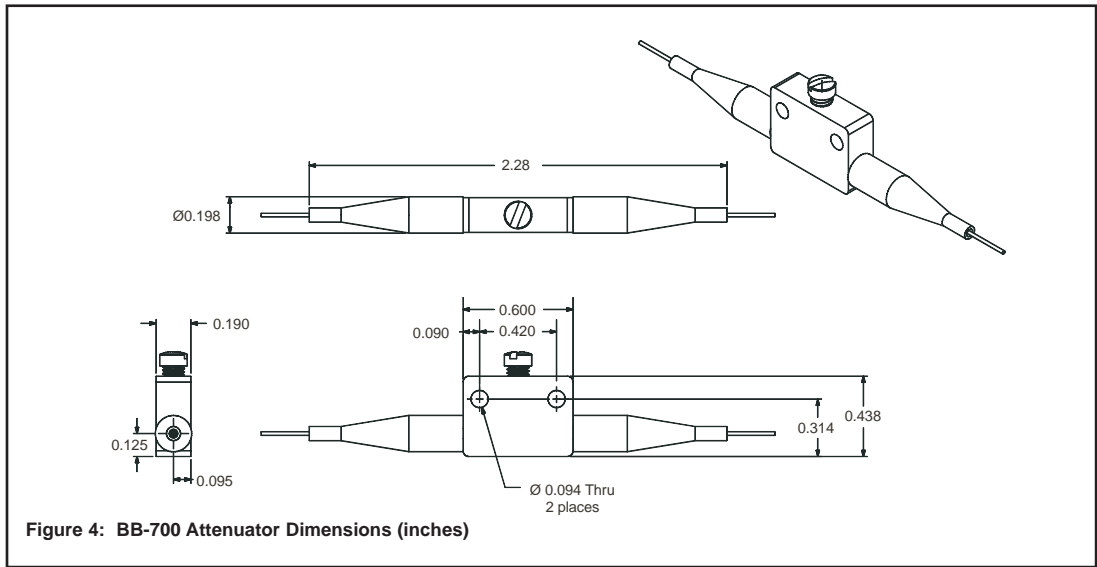
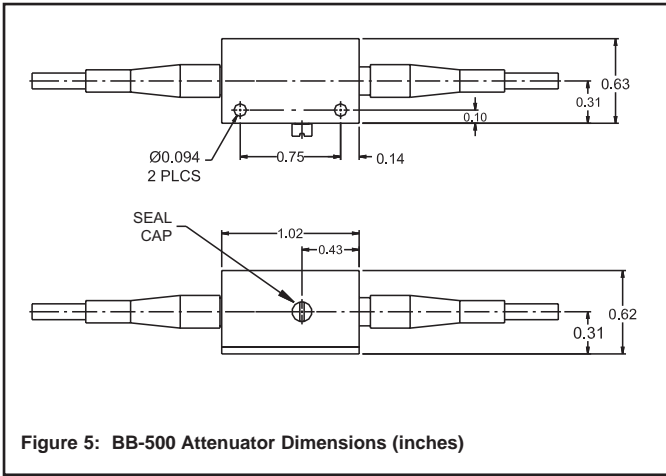
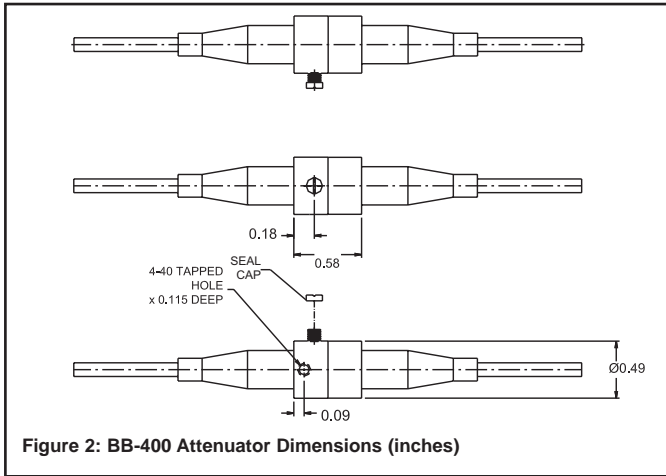
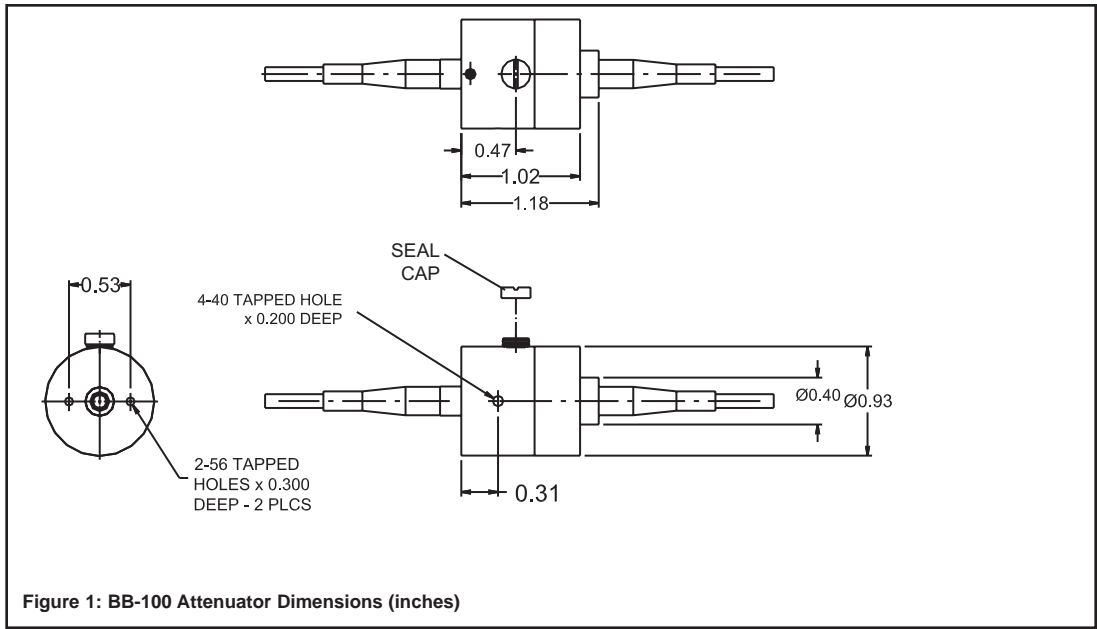

Ordering Information For Standard Parts:

BC#	PART NUMBER	DESCRIPTION
185	BB-100-11-1300/1550-9/125-S-40-XX-3-1	Pigtail style variable attenuator at 1300/1550nm with 1m long, 3mm OD jacketed unterminated singlemode fiber on both ends, 40dB return loss and in 24mm round housing.
10574	BB-100-11-1300/1550-9/125-S-40-3S3S-3-1	Pigtail style variable attenuator at 1300/1550nm with 1m long, 3mm OD jacketed singlemode fiber with FC/Super PC connectors on both ends, 40dB return loss and in 24mm round housing.
12292	BB-100-11-1300/1550-9/125-S-40-3S3S-3-1-LL	Pigtail style variable attenuator at 1300/1550nm with 1m long, 3mm OD jacketed singlemode fiber with FC/Super PC connectors on both ends, 40dB return loss and in 24mm round housing. IL ≤ 1dB
10489	BB-100-11-1300/1550-9/125-S-40-SCSC-3-1	Pigtail style variable attenuator at 1300/1550nm with 1m long, 3mm OD jacketed singlemode fiber with SC/Super PC connectors on both ends, 40dB return loss and in 24mm round housing.
10172	BB-100-11-1300/1550-9/125-S-50-SCUSCU-3-1	Pigtail style variable attenuator at 1300/1550nm with 1m long, 3mm OD jacketed singlemode fiber with SC/Ultra PC connectors on both ends, 50dB return loss and in 24mm round housing.
2172	BB-100-11-1300/1550-9/125-S-60-XX-3-1	Pigtail style variable attenuator at 1300/1550nm with 1m long, 3mm OD jacketed singlemode unterminated fiber on both ends, 60dB return loss and in 24mm round housing.
4006	BB-100-11-1300/1550-9/125-S-60-XX-3-1-LL	Pigtail style variable attenuator at 1300/1550nm with 1m long, 3mm OD jacketed singlemode unterminated fiber on both ends, 60dB return loss and in 24mm round housing. IL ≤ 0.6dB
8726	BB-100-11-1300/1550-9/125-S-60-3A3A-3-1	Pigtail style variable attenuator at 1300/1550nm with 1m long, 3mm OD jacketed singlemode fiber with FC/Angle PC connectors on both ends, 60dB return loss and in 24mm round housing.
5819	BB-100-11-1300/1550-9/125-P-40-3S3S-3-1	Pigtail style variable attenuator at 1300/1550nm with 1m long, 3mm OD jacketed PM fiber with FC/Super PC connectors on both ends, 40dB return loss and in 24mm round housing.
7504	BB-100-11-1300/1550-9/125-P-60-3A3A-3-1	Pigtail style variable attenuator at 1300/1550nm with 1m long, 3mm OD jacketed PM fiber with FC/Angle PC connectors on both ends, 60dB return loss and in 24mm round housing.
12903	BB-100-11-850-50/125-M-35-3S3S-3-1	Pigtail style variable attenuator at 850nm with 1m long, 3mm OD jacketed 50/125 micron multimode fiber with FC/Super PC connectors on both ends, 35dB return loss and in 24mm round housing.
2542	BB-400-11-1300/1550-9/125-S-40-XX-3-1	Pigtail style variable attenuator at 1300/1550nm with 1m long, 3mm OD jacketed singlemode unterminated fiber on both ends, 40dB return loss and in 12mm round housing.
4161	BB-400-11-1300/1550-9/125-S-40-3S3S-3-1	Pigtail style variable attenuator at 1300/1550nm with 1m long, 3mm OD jacketed singlemode fiber with FC/Super PC connectors on both ends, 40dB return loss and in 12mm round housing.
10739	BB-400-11-1300/1550-9/125-S-50-3U3U-3-1	Pigtail style variable attenuator at 1300/1550nm with 1m long, 3mm OD jacketed singlemode fiber with FC/Ultra PC connectors on both ends, 50dB return loss and in 12mm round housing.
4133	BB-400-11-1300/1550-9/125-S-60-XX-3-1	Pigtail style variable attenuator at 1300/1550nm with 1m long, 3mm OD jacketed singlemode unterminated fiber on both ends, 60dB return loss and in 12mm round housing.
8727	BB-400-11-1300/1550-9/125-S-60-SCSC-3-1	Pigtail style variable attenuator at 1300/1550nm with 1m long, 3mm OD jacketed singlemode fiber with SC/PC connectors on both ends, 60dB return loss and in 12mm round housing.
10931	BB-400-11-1550-8/125-P-50-3U3U-1-1-LL	Pigtail style variable attenuator at 1550nm with 1m long, 0.9mm OD jacketed PM fiber with FC/Ultra PC connectors on both ends, 50dB return loss and in 12mm round housing. IL ≤ 1dB
2712	BB-500-11-1300/1550-9/125-S-40-XX-3-1	Pigtail style variable attenuator at 1300/1550nm with 1m long, 3mm OD jacketed singlemode unterminated fiber on both ends, 40dB return loss and in rectangular housing.
8034	BB-500-11-1300/1550-9/125-S-40-3S3S-3-1	Pigtail style variable attenuator at 1300/1550nm with 1m long, 3mm OD jacketed singlemode fiber with FC/Super PC connectors on both ends, 40dB return loss and in rectangular housing.
5851	BB-500-11-1300/1550-9/125-S-50-3U3U-3-1	Pigtail style variable attenuator at 1300/1550nm with 1m long, 3mm OD jacketed singlemode fiber with FC/Ultra PC connectors on both ends, 50dB return loss and in rectangular housing.
11829	BB-500-11-1300/1550-9/125-S-60-3A3A-3-1	Pigtail style variable attenuator at 1300/1550nm with 1m long, 3mm OD jacketed singlemode fiber with FC/Angle PC connectors on both ends, 60dB return loss and in rectangular housing.

Ordering Examples For Standard Parts:

A customer needs an attenuator for 1300nm with FC Super polished connectors, 9/125 micron, 3mm OD cabled, 1m long singlemode fibers on both ends with 40dB back reflection. Any of the following standard parts will do the job:

Bar Code	Part Number	Description
10574	BB-100-11-1300/1550-9/125-S-40-3S3S-3-1	Pigtail style variable attenuator at 1300/1550nm with 1m long, 3mm OD jacketed singlemode fiber with FC/Super PC connectors on both ends, 40dB return loss and in 24mm round housing.
4161	BB-400-11-1300/1550-9/125-S-40-3S3S-3-1	Pigtail style variable attenuator at 1300/1550nm with 1m long, 3mm OD jacketed singlemode fiber with FC/Super PC connectors on both ends, 40dB return loss and in 12mm round housing.
8034	BB-500-11-1300/1550-9/125-S-40-3S3S-3-1	Pigtail style variable attenuator at 1300/1550nm with 1m long, 3mm OD jacketed singlemode fiber with FC/Super PC connectors on both ends, 40dB return loss and in rectangular housing.

Ordering Information For Custom Parts:

OZ Optics welcomes the opportunity to provide custom designed products to meet your application needs. As with most manufacturers, customized products do take additional effort so please expect some differences in the pricing compared to our standard parts list. In particular, we will need additional time to prepare a comprehensive quotation, and lead times will be longer than normal. In most cases non-recurring engineering (NRE) charges, lot charges, and a 10 piece minimum order will be necessary. These points will be carefully explained in your quotation, so your decision will be as well-informed as possible. We strongly recommend buying our standard products

Questionnaire For Custom Parts:

1. What wavelengths are you operating at?
2. How much power will be transmitted through the attenuator?
3. What type of fiber do you wish to use?
4. What is fiber length and jacket OD?
5. What is the worst acceptable return loss?
6. Do you need a variable or fixed attenuation level?
7. What connectors do you need at each end of fiber?
8. What size of attenuator do you prefer?
9. What environmental requirements do you need to meet?
10. Are there any special performance requirements that you need to meet?

Description

Pigtail style inline variable attenuator

A = Attenuator Size

- 100 = 24mm Diameter Housing
- 400 = 12mm Diameter Housing
- 500 = Rectangular Housing
- 700 = Miniature Housing

W = Wavelength: Specify in nanometers
Example: 1300/1550 for 1300 to 1550nm wavelength range

a/b = Fiber core/cladding sizes, in microns
9/125 for 1300/1550nm SM fiber. See the OZ Standard Tables data sheet for other standard fiber sizes

F = Fiber Type:

- S = Singlemode
- M = Multimode
- P = Polarization maintaining

LB = Backreflection level:

40, 50 or 60dB³ for singlemode or PM fibers, 35dB for MM fibers

Part Number

BB-A-11-W-a/b-F-LB-XY-JD-L(-OPT) ←

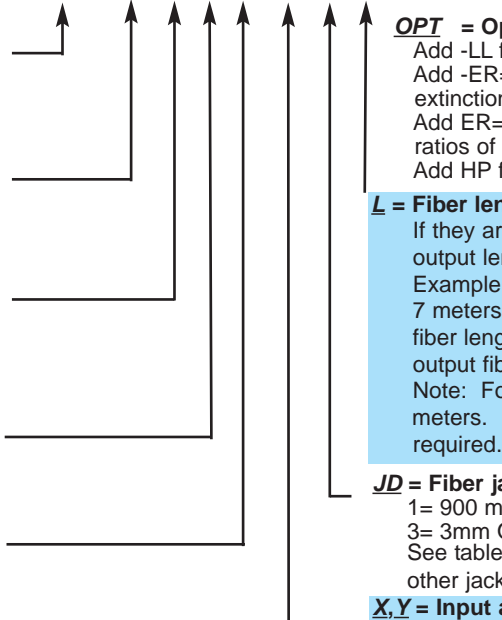

OPT = Options:

- Add -LL for low loss attenuators¹
- Add -ER=25 for PM attenuators with minimum extinction ratios of 25dB²
- Add ER=30 for PM attenuators with typical extinction ratios of 30dB²
- Add HP for High power version

L = Fiber length in meters, on each side of the device.

If they are different lengths, specify the input and output lengths separated by a comma.
Example: To order 1meter of the fiber at the input and 7 meters at the output, replace the L with 1,7. The total fiber length is equal to the input fiber length plus the output fiber length.
Note: For LB=60dB the normal maximum length is 2 meters. For longer lengths a separate lot charge is required.

JD = Fiber jacket type:

- 1= 900 micron OD hytel jacket
- 3= 3mm OD Kevlar reinforced PVC cable
- See table 7 of the OZ Standard Tables data sheet for other jacket sizes

X,Y = Input and Output Connector codes:

- X = No connector
- 3S = Super NTT-FC/PC
- 3U = Ultra NTT-FC/PC
- 3A = Angled NTT-FC/PC
- 8 = AT & T-ST
- SC = SC
- SCA = Angled SC
- LC = LC/PC
- LCA = Angled LC
- See table 6 of the OZ Standard Tables data sheet for other connectors

Note 1: LL = 0.6dB with units that have 60dB return loss, LL = 1dB for rest of the attenuators.

Note 2: If ER not specified, the default value is 20dB

Note 3: 60dB return losses are normally only available for 1300/1550nm wavelengths. For other wavelengths a separate lot charge is required.

Ordering Examples For Custom Parts:

1. A customer wants to order a 24mm OD round housing singlemode attenuator at 1300nm, with 2 meter long and 900 micron cabled fiber on both sides with FC super PC polished connectors and 40dB backreflection with low loss.
The part number should be: **BB-100-11-1300/1550-9/125-S-40-3S3S-1-2-LL**
2. A customer wants to order a pigtail variable attenuator at 850nm in rectangular housing with 5/125 singlemode fiber, 3m at input, 2m at output, 3mm OD cabled, with no connectors and 40dB backreflection.
The part number should be: **BB-500-11-850-5/125-S-40-XX-3-3,2**
3. A customer wants a standard attenuator for the C (1520-1570 nm) and L (1570-1620) wavelength bands. He wants the miniature 12 mm diameter size. He wants 60 dB return loss, standard Corning SMF-28 singlemode fiber, with 3 mm cabling, and FC/APC connectors. The total length of the device should be three meters, with the attenuator in the middle.
The part number will be: **BB-400-11-1300/1550-9/125-S-60-3A3A-3-1.5**

Frequently Asked Questions (FAQs):

Q: What advantages or disadvantages does the beam blocking version have over the neutral density versions.

A: The beam blocking technique is naturally suited for high power applications, and can achieve greater attenuation levels. The neutral density version shows less mode dependence or modal noise in multimode applications.

Q: What do you mean by mode dependence and modal noise?

A: The term multimode means there is more than one path for light to travel inside a single fiber. These paths are known as modes. It does not mean the unit consists of multiple fibers in a bundle. When coherent laser light is coupled into multimode fiber, the output shows speckles. Bending the fiber causes the speckle pattern to change. If the losses in a system depend on which modes are excited, then changing the modes excited in the fiber changes the output power. This is known as modal noise. If the source being used is an LED, then one does not see speckles, and modal noise is not an issue. However, for laser sources, modal noise is an issue.

When blocking style attenuators are used with multimode fiber, some modes are blocked, while others are transmitted. This can produce 1dB or greater modal noise fluctuations with coherent sources. A variable attenuator using a neutral density filter is not as strongly affected by modal noise. However, neutral density filter attenuators offer lower attenuation range (around 40dB) and can only handle about 50mW of power.

Q: What are the standard numerical apertures (NA) for the fibers used in your attenuators? Should I specify the NA of the fiber when I'm ordering an pigtail style attenuator?

A: Please see our standard tables data sheet for detailed information on our fibers. If you want to use fiber that hasn't been specified in the standard tables then you should specify it while ordering.

Q: I ordered an attenuator with 60dB return loss but when I measured it my return losses are higher. Why?

A: If you ordered an attenuator with 60dB return loss with connectors, the back reflection will depend on what grade of connector you selected for your fibers. Typically only angle polished (APC) style connectors will give the desired return losses. The device itself has 60dB return loss (i.e. if you cut off the connectors and measured the return loss you will see it above 60dB) but if you picked only ultra PC finish connectors you may only see from 50 to 55dB return losses.

Q: Do 1300/1550nm attenuators work at other wavelengths?

A: Yes, they do. They can also be used for the S (1470-1520nm), C (1520-1570nm) and L (1570-1620nm) bands, with little variation in attenuation.

Application Notes:

One of the important applications of attenuators is channel balancing in WDMs. Attenuators can be adjusted to different attenuation levels so that all signals produce similar power levels at the receiver end. Each channel may have different output levels. By adjusting the power level of each channel by using the attenuators, one can balance the power.

